

Got Bugs?

Get Bats!

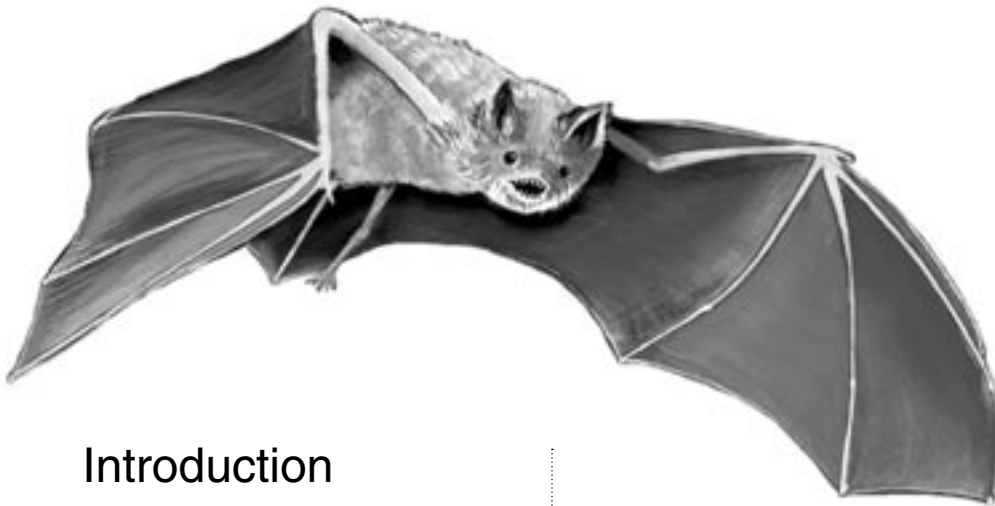

Illustration courtesy of Angie Franco.

Introduction

Bats are one of Maryland's most valuable natural resources. However, they are also one of the most misunderstood and falsely accused of all creatures in the animal kingdom. Movies often portray bats as blood-sucking, rabies-infested, vicious creatures that like to fly into women's hair. But contrary to popular folklore, all the bat species found in Maryland eat only insects. They do not suck blood and their rate of rabies is considered to be half of one percent in the wild. Many more people die each year from bee stings or dog attacks than from rabies contracted from a bat. Needless to say, the public health threat from bats has been overestimated. Even so, bats are wild animals and will bite when handled, so it is recommended not to pick up bats whether alive or dead.

Finally, bats do not fly into women's hair and actually try to avoid human contact.

Many people are wary of bats because of their looks and erratic flight. Bats navigate by echolocation, which is a means of bouncing sounds off of objects to determine their size and location. In most cases, if a bat flies near you, it is pursuing an insect that is flying close by.

Bats may not be considered one of the most attractive creatures in the animal kingdom but they are an integral part of the food chain and also provide benefits to humans. This fact sheet will describe the important role bats play in controlling insects and will provide information that can be used to attract bats to your area. Instructions for

removing bats from inside your house are also included.

How Do Bats Help People?

Bats are the primary consumer of nighttime flying insects. They eat hundreds of different insect pests, including mosquitoes. Many of the pests that the agricultural community and general public try to control with insecticides are eaten by bats. The insect eating capabilities of bats are quite significant. One little brown bat, which is a species common to Maryland, can eat approximately 1,200 mosquito-size insects per hour. A typical colony of 150 big brown bats, also found in Maryland, can protect local farmers from the costly attacks of 33 million root worms each summer. Other insect pests on the bat's menu include cucumber and June beetles, stink bugs, leafhoppers, cutworm and corn ear worm moths. There are many other insect species not listed here that bats eat every night during the warmer months of the year.

How to Provide Habitat for Bats

The habitat requirements for bats are fairly simple, but attracting bats isn't always easy. They are one of the most finicky of creatures when it comes to their shelter requirements. Bats may occupy human-constructed housing if it is properly built and placed in a suitable area.

Of the 10 species of bats found in Maryland, five are most likely to inhabit houses built by humans. These five species are the little brown bat (*Myotis lucifugus*), big brown bat (*Eptesicus fuscus*), the evening bat (*Nycticeius humeralis*), Northern long-eared bat (*Myotis septentrionalis*), and Eastern Pipistrelle (*Pipistrellus subflavus*). The other species that normally do not use bat houses are the Indiana bat, small-footed bat, silver-haired bat, red bat, and hoary bat.

The temperature inside the bat house is one of the most critical elements in attracting bats. Providing a variety of different temperature ranges for bats can be effective in attracting and keeping a colony of bats. One way to maintain a variety of tempera-

tures is to construct multiple bat houses in either a different design or with a different exterior color. Darker exterior colors will keep more heat in the box, which may be beneficial during the cooler spring months. But during the hot summer months, a dark exterior may increase the risk of the bats overheating and abandoning the roost. For this reason, a lighter colored bat house situated adjacent to the darker house may provide the needed difference in temperatures. Also, ventilation slits can be incorporated into the design to help prevent boxes from getting too hot in the summer.

Bat House Specifics

Sun exposure: The amount of exposure to the sun a bat house receives is more important in areas north of Maryland and less important south of Maryland. In Maryland, bat houses should receive at least 5 to 7 hours of direct sunlight. As noted earlier, providing two houses back to back, one light brown and one dark brown should provide the bats with a greater range of temperatures to choose from throughout the day. If the bats get too hot or too cold during the day, they will often crawl into the other house to help regulate their temperature. In Western Maryland, bat houses should be almost black.

Height above the ground: Studies indicate the higher the bat house, the more likely it is to be inhabited. Occupancy rates will most likely be highest in houses situated at a minimum height of 12 feet, but 15 feet or higher is recommended. The base of the posts or poles should have a predator baffle attached to prevent predators such as cats and raccoons from raiding the house. Aluminum flashing wrapped around the poles at a height of 4 feet above the ground will serve as an effective baffle. Bat houses may be mounted on houses or barns only if the bat house will receive a minimum of 5 hours of direct sunlight.

Size: The larger the bat house, the greater the number of bats may fit. A house with the dimensions 36"H x 24"W x 10"D will accommodate approximately 300 bats. Larger houses are also more effective in providing the space necessary for breeding females and their pups. Many of the small

bat houses available on the market are ineffective and not often used by bats. The plans for two different size bat houses are included in this fact sheet (refer to appendix).

Proximity to Water: Bat houses located one-quarter of a mile from a stream, river, lake, or pond are more likely to attract bats. The size of the body of water is not a significant factor.

Open area: Bat houses erected in open, nonforested areas are more likely to attract bats. Bats prefer to have few flight obstacles, and for this reason open areas are suggested over forested areas. Bat houses can also be mounted on the side of a barn or other structure if it is at the proper height and receives 5 to 7 hours of direct sunlight.

- The success of bats occupying bat houses depends on bat populations in the area, the suitability of present roosts, and the diversity of habitat types, which provides more food sources. Maryland bats historically occupied dead and dying trees in the landscape, many of which have been removed, which is the reason bats have switched to human houses in the first place. The amount of displacement from their roosts also influences the success of bat boxes.

Are Bats in Your House?

The Facts on Excluding Bats

Under the Maryland Nongame and Endangered Species Conservation Act, bats receive protection. It is against the law to “take” any bat, which means to harass, harm, pursue, hunt, shoot, wound, kill, trap, capture, or collect, or to attempt to engage in this conduct. For this reason, it is important to learn how to properly manage any bats that may be roosting in your house.

When Should I Bat Proof My House?

- It is important to note that in Maryland, only bat exclusion professionals with a permit from the Department of Natural Resources are allowed to do bat exclusion work. A list of these businesses and individuals is available by contacting the Maryland Department of Natural Resources (DNR).

Just like any other wild animal, bats do not belong inside peoples’ houses. If bats are occupying the eaves or another location in your house, it is best to exclude them from the house. According to Maryland DNR

recommendations, bat proofing your house should be done after September 1 and before hibernation begins, which is normally in November. Bat proofing should not be done during the late spring and summer months. During the summer, bat pups are dependent upon their mothers for milk and will not leave their roosting area until mid- to late July. If a house is bat proofed between May 1 and August 31, the likelihood of trapping a bat pup in your house increases. This should be avoided because the pup will most likely die and decay causing bad odors. Also, the mothers may try to get to their pups, which could lead to them finding another way into your house.

Exclusion during winter should also be avoided because certain species may hibernate in houses. Big brown bats have been known to hibernate in houses and even in properly constructed and located bat houses. Unless you are absolutely sure there are not any hibernating bats in your home, it is advised not to exclude during winter to avoid trapping hibernating bats inside.

Prior to excluding bats from a house, it is recommended to provide the bats with an alternate roosting site. This may be accomplished by erecting a bat house, like the ones produced by following the guidelines provided in this fact sheet. The first step in excluding bats from a house is to determine where they are gaining access. Once the access point has been identified, exclusion can begin.

One-way devices constructed from lightweight polypropylene netting (< 1/8” mesh), plastic sheeting, or tube-type excluders are the preferred methods for evicting bats from buildings (please refer to the illustration on page 4). Excluders should be placed at all active entry points and should remain in place for at least 5 to 7 days. These devices should be removed after the bats have been excluded, and then exclusion points should be sealed with silicone caulking, caulk backing rod, hardware cloth, or heavy duty polypropylene mesh. In some cases, sealing may require repair or replacement of old, deteriorated wood. It is recommended that exclusion professionals bat-proof the entire house and avoid spot treatments. Moving bats from one corner of a building to another does not solve the problem and may require that

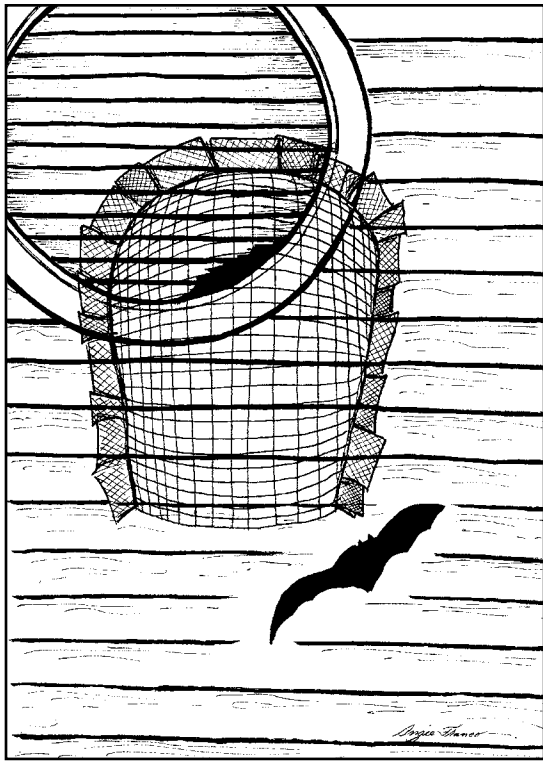

Illustration courtesy of Angie Franco.

more exclusion work is carried out at some time in the future, further disturbing the bats and the property owner.

- Please note that simply waiting until the bats have flown out at night and then permanently sealing entrances shut without the use of exclusion devices, is not recommended. This method often traps bats inside the building.

Finally, if you have a colony of bats roosting in your house or another building, it is beneficial, for you and the bats, to provide them with an alternative roost site and then exclude them from the unwanted location. Bats are very effective in naturally suppressing insect pest populations. Encourage bats to live in your area by erecting bat houses

and discourage them from gaining access to your house by following the guidelines outlined above.

References

- Maryland Department of Natural Resources. *Bats of Maryland*. Annapolis: Wildlife and Heritage Division.
- Tuttle, M., and Hensley, D. 1993. *The Bat House Builder's Handbook*. Austin: Bat Conservation International.
- Williams, K. and Mies, R. 1996. *Understanding Bats*. Marietta: Bird Watcher's Digest Press.
- Williams-Whitmer, L., and Brittingham, M. 1995. *A Homeowner's Guide to Northeastern Bats and Bat Problems*. University Park: Penn State College of Agricultural Sciences, Cooperative Extension.

Additional Resources

Maryland Department of Natural Resources
Wildlife Hotline Number
(877) 463-6497

Bat Conservation International, Inc.
P.O. Box 162603
Austin, TX 78716-2603
(512) 327-9721
www.batcon.org

Organization for Bat Conservation
1553 Haslett Road
Haslett, MI 48840
(517) 339-5200
www.batconservation.org

APPENDIX

The following bat house plans were reproduced with permission from *Woodcrafting for Wildlife* by the Pennsylvania Game Commission.

Standard Bat House

SUPPLIES NEEDED:

LUMBER:

4' X 4' X 1/2" CDX EXTERIOR PLYWOOD
 4' X 8' X 3/8" CDX EXTERIOR PLYWOOD
 1" X 8" X 8' BOARD
 1" X 8" X 4' BOARD

OTHER TOOLS AND SUPPLIES NEEDED:

SCREW DRIVER (PREFERABLY ELECTRIC)

1 - 1/4" LONG WOOD OR GALVANIZED DRYWALL SCREWS (1LB). SCREWS ARE REQUIRED FOR ASSEMBLY.

CAULKING: TUBE OF BLACK ROOF CEMENT

CAULKING GUN FOR ABOVE

BLACK, MATT FINISH; DARK BASE, SOLID COLOR ACRYLIC EXTERIOR STAIN (ONE QUART)

BLACK ROLLED ROOFING: 25 - 1/2" X 9 - 3/4"

STAPLE GUN WITH 3/8" STAPLES

UTILITY KNIFE WITH SNAP-OFF BLADES

FIBERGLASS WINDOW SCREENING: 22" X 6"

ASSEMBLY INSTRUCTIONS:

The bat box plan has been successful in attracting nursery colonies of Little Brown and Big Brown Bats.

Bat roosting requirements are strict, necessitating adherence to construction details.

1. Cut out parts as illustrated.

2. Apply a bead of caulk to front edges of box SIDES & attach box FRONT with 6-8 screws per side. Clean excess caulk that squeezes out.

3. Score inside of front and sides with utility knife to roughen. Also score bottom 4-1/2" on outside of box FRONT below vents. Make horizontal scratches 1/4" apart. While the knife is out, score both sides of all ROOSTING BAFFLES and the interior side of box BACK. These are landing/roosting footholds and are VERY IMPORTANT. Do not use saw to roughen, this will cause plywood to delaminate.

LANDING PLATE AND INTERIOR SURFACES MUST BE ROUGHENED.

4. Attach 2 BAFFLE SPACERS to inside front corners with two screws each, and screwed in from front of box. Space about 2 inches from top of box FRONT with 3/4" dimension to sides. Lay assembled parts FRONT down on table or floor.

5. Attach SHORT ROOST BAFFLE to spacers about 1" down from top of sides. Use 2 screws on each side.

6. Attach two BAFFLE SPACERS into new corners made by short roost baffle. Use 2 screws on each side.

7. Attach LONG ROOST BAFFLE to spacers about 1" down from top of sides. Use two screws on each side.

8. Repeat installation of BAFFLE SPACERS and ROOST BAFFLES, alternating short and long roost baffles until six ROOST BAFFLES are in. The last two baffle spacers should be attached to previously affixed BAFFLE and box SIDES for stability.

9. Caulk back edges of box SIDES and attach box BACK with scored side in. Do not caulk inside vent areas. The BACK should extend 2" above top of SIDES. Use 6-8 screws on each side. Clean excess caulk that should squeeze out.

10. Center ROOF SUPPORT on inside top of box FRONT. Align angled edge with top edge of FRONT and SIDES. Attach with 3 screws through the box FRONT.

11. Center ROOF SUPPORT on inside and 2" below top of box BACK. Align angled edge with top edges of SIDES. Attach with 3 screws through box BACK.

12. Apply bead of caulk to top of SIDES, FRONT, two ROOF SUPPORTS and angled back edge of ROOF.

13. Lay ROOF in position and attach with at least three screws on each SIDE, FRONT and BACK. Clean excess caulk.

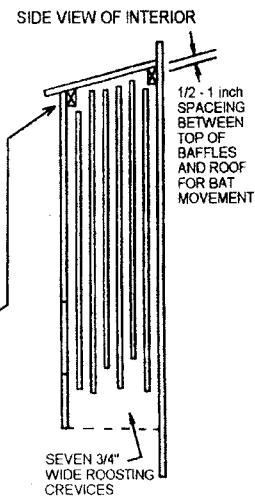
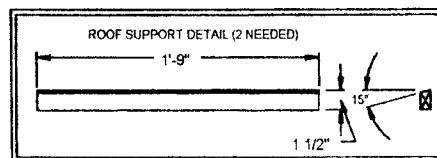
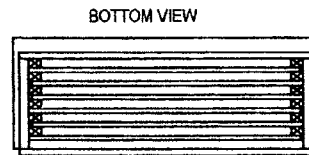
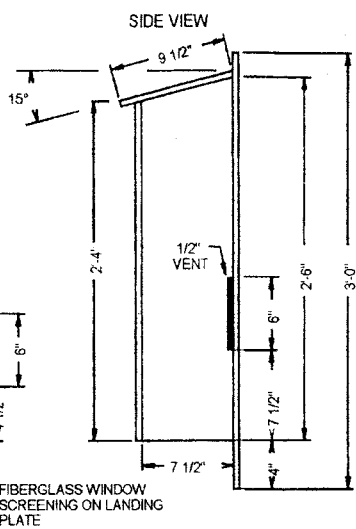
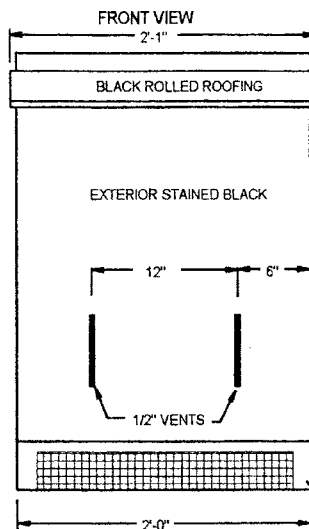
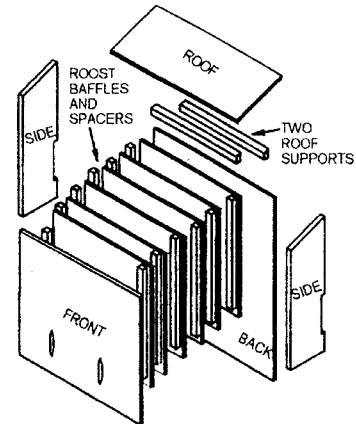
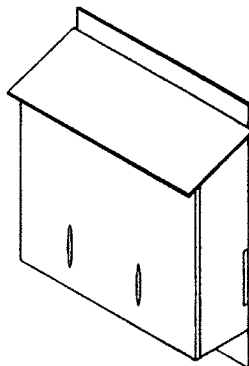

Standard Bat House Continued

14. Caulk back of roof top where it butts against the back. Smooth with damp towel. Inspect all other caulked seams and caulk exterior seams as necessary.

TOP OF BOX MUST BE AIR TIGHT SO IT CAN HOLD HEAT.

15. Apply two or three coats of stain to exterior, including the landing plate.

16. Cut section of black rolled roofing to fit on roof top. Apply thin bead of caulk around top of roof edges. Set rolled roofing into position and staple down. Caulk back edge of rolled roofing where it butts against box BACK. Caulk exposed staples on rolled roofing surface.

17. Cut out piece of fiberglass window screening to fit on landing plate to provide a good landing platform. Staple to bottom front of box BACK. Coat exposed staples with black stain. Landing plate should be roughened under screening since screening may eventually fall off.

Attach box at least 10 feet high to a building or pole. See pole mounting directions. Orient box to southeast to catch the morning sun if possible. If not possible, orient between the southeast and southwest to get at least seven hours of direct sun. Many successful bat boxes get 12 hours of direct sun.

If bat box is used in combination with bat eviction from building, DO NOT EVICT BATS BETWEEN MID-MAY AND THE END OF JULY WHEN FLIGHTLESS YOUNG MAY BE TRAPPED INSIDE BUILDING.

Maximum Capacity: 250 Bats

This box can hold up to 250 bats comfortably. If over 250 bats use this box, heat stress can cause problems on hot, humid days. Should more capacity be needed, additional boxes can be placed side by side.

If wasps become a problem, use a long thin stick to scrape nests out in winter. New nests can be knocked out in May or early June, during cool mornings or evenings, when wasps are less aggressive. If bats are present, don't disturb. Bats and wasps can coexist in boxes. Bats provide travel lanes for wasps to reach their nests. Wasps, in turn, provide some protection against box disturbance.

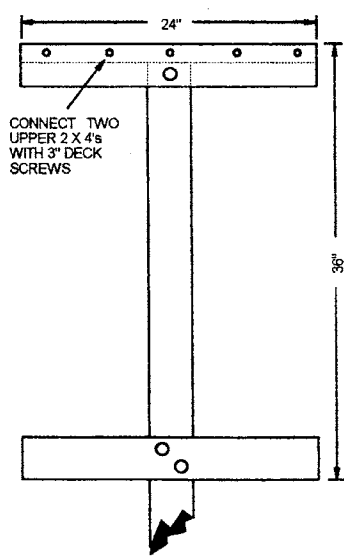
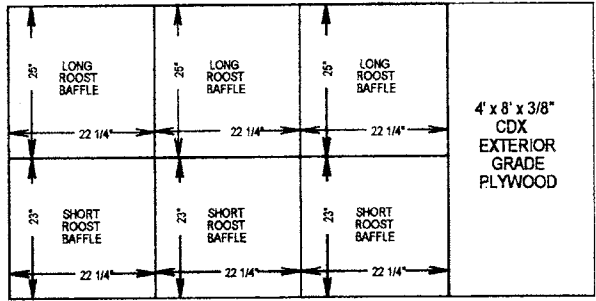
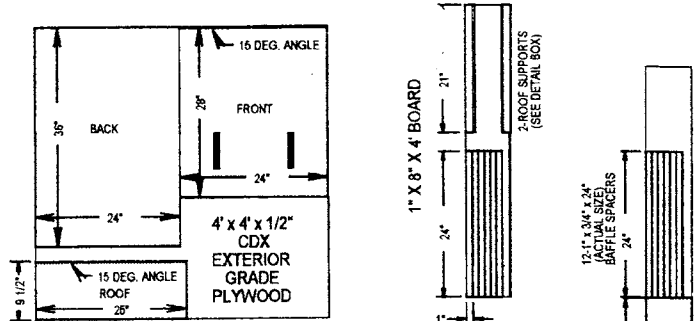

CONNECT TWO UPPER 2 X 4'S WITH 3" DECK SCREWS

ATTACH 2 X 4 MOUNTS TO POLE WITH FIVE 3/8" X 3" LAG BOLTS AND 1" FLAT WASHERS.

PREDRILL 2 X 4'S WITH 3/8" BIT. USE 3/16" BIT FOR PILOT HOLES INTO POST

PRESSURE TREATED 4" X 4" X 16' POST

TWO 3/8" X 3" LAG BOLTS AND WASHERS

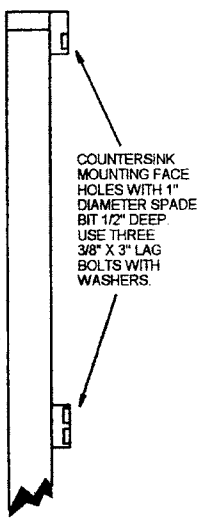

COUNTERSINK MOUNTING FACE HOLES WITH 1" DIAMETER SPADE BIT 1/2" DEEP. USE THREE 3/8" X 3" LAG BOLTS WITH WASHERS.

ATTACH BOX TO MOUNTS WITH 1.5" DECK SCREWS

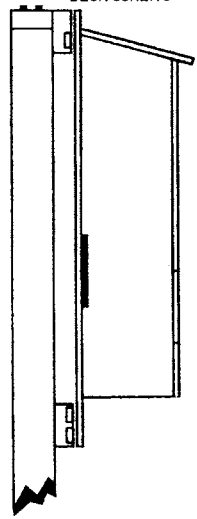

Got Bugs? Get Bats!

by

M. Allan Daly
Extension Educator
Baltimore County

Reviewed by:

Elijah Goodwin
Organismic and Evolutionary Biology
University of Massachusetts

Dana Limpert
Ecologist
Maryland Department of Natural Resources

Jonathan Kays
Regional Specialist, Natural Resources
Maryland Cooperative Extension

Robert Tjaden
Regional Specialist, Natural Resources
Maryland Cooperative Extension

Issued in furtherance of Cooperative Extension work, acts of May 8 and June 30, 1914, in cooperation with the U.S. Department of Agriculture, University of Maryland, College Park, and local governments. Bruce Gardner, Interim Director of Maryland Cooperative Extension, University of Maryland.

The University of Maryland is equal opportunity. The University's policies, programs, and activities are in conformance with pertinent Federal and State laws and regulations on nondiscrimination regarding race, color, religion, age, national origin, gender, sexual orientation, marital or parental status, or disability. Inquiries regarding compliance with Title VI of the Civil Rights Act of 1964, as amended; Title IX of the Educational Amendments; Section 504 of the Rehabilitation Act of 1973; and the Americans With Disabilities Act of 1990; or related legal requirements should be directed to the Director of Human Resources Management, Office of the Dean, College of Agriculture and Natural Resources, Symons Hall, College Park, MD 20742.

R2004

